

**AP Serie Shimadzu Analysenwaage Laborwaage**  
**Eine der schnellsten Waagen der Welt**



Semimikrowaage für Labor, Pharma und Industrie  
 Superschnell, verbesserte Präzision und Genauigkeit  
 Eingebauter Ionisator (optional)







- **Shimadzu AP Serie**
- **Laborwaage Analysenwaage für Pharma, Industrie und Analyse**
- Semimikrowaage
- Goldwaage, Präzisionswaage
- eichfähig
- **Wägen, tarieren, zählen**
- Beseitigen statischer Ladung durch Stablo AP (Optional)
- USB Host für Tastatur, Scanner, USB -Speichergerät (W-Series)
- USB-Device für Drucker und PC (alle)
- Interner Kalibrierung
- Überlastschutz, robust
- Automatische Abschaltung
- RS 232 Schnittstelle
- OEL Display- Punktmatrix
- Wiegeplatte Ø 91mm
- Eingebauter Ionisator (optional erhältlich)

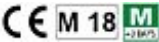

Analysewaage:	Wägebereich:	Teilung:	Kalibrierung:	Hersteller:
AP135W	135g	0.01mg	intern	Shimadzu
AP125WD	120g / 52g	0.01mg / 0.1mg	intern	Shimadzu
AP225WD	220g / 102g	0.01mg / 0.1mg	intern	Shimadzu
AP124W	120g	0.1mg	intern	Shimadzu
AP224W	220g	0.1mg	intern	Shimadzu
AP324W	320g	0.1mg	intern	Shimadzu
AP124X	120g	0.1mg	intern	Shimadzu
AP224X	220g	0.1mg	intern	Shimadzu
AP324X	320g	0.1mg	intern	Shimadzu

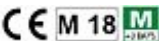
## Varianten

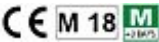
## Preis

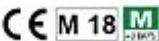
	<b>AP135W</b> Wägebereich 135 g, Teilung 0.01mg sofort lieferbar	Fr. 4190.00
	Eichung zu AP135W e = 1 mg sofort lieferbar	Fr. 185.00
	<b>AP125WD</b> Wägebereich 120g / 52g, Teilung 0.01mg/ 0.1mg sofort lieferbar	Fr. 4120.00
	Eichung zu AP125WD e = 1 mg sofort lieferbar	Fr. 185.00
	<b>AP225WD</b> Wägebereich 220g/ 102g, Teilung 0.01mg/ 0.1mg sofort lieferbar	Fr. 4060.00
	Eichung zu AP225WD e = 1 mg sofort lieferbar	Fr. 185.00
	<b>AP124W</b> Wägebereich 120g, Teilung 0.1mg sofort lieferbar	Fr. 3220.00
	Eichung zu AP124W e = 1 mg sofort lieferbar	Fr. 185.00



**AP224W**  
Wägebereich 220g, Teilung 0.1mg  
sofort lieferbar

Fr. 3560.00

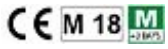

Eichung zu AP224W  
e = 1 mg  
sofort lieferbar

Fr. 185.00



**AP324W**  
Wägebereich 320g, Teilung 0.1mg  
sofort lieferbar

Fr. 3860.00



Eichung zu AP324W  
e = 1 mg  
sofort lieferbar

Fr. 185.00



**AP124X**  
Wägebereich 120g, Teilung 0.1mg  
sofort lieferbar

Fr. 2880.00

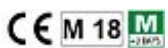

Eichung zu AP124X  
e = 1 mg  
sofort lieferbar

Fr. 185.00



**AP224X**  
Wägebereich 220g, Teilung 0.1mg  
sofort lieferbar

Fr. 3220.00

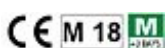

Eichung zu AP224X  
e = 1 mg  
sofort lieferbar

Fr. 185.00



**AP324X**  
Wägebereich 320g, Teilung 0.1mg  
sofort lieferbar

Fr. 3390.00

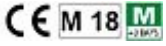

Eichung zu AP324X  
e = 1 mg  
sofort lieferbar

Fr. 185.00

#### Zubehör

#### Preis



**Shimadzu Stablo AP**  
Beseitigt elektrostatische Ladung  
sofort lieferbar

Fr. 1280.00



Antivibrationstisch robuste Konstruktion, 800x600mm, mit Granitplatte  
400x450mm  
2 Teilig  
lieferbar in 7 Tagen

Fr. 1435.00

**Swiss Waagen DC GmbH**

Usterstrasse 31 CH-8614 Bertschikon/ZH  
Telefon +41 (0)43 843 95 90 Fax +41 (0)43 843 95 92  
info@swisswaagen.ch www.swisswaagen.ch  
CHE-110.606.498 MWST

  
**SWISSwaagen.ch**

Advanced Performance UniBloc Balances

# AP Series



# AP Series

Advanced Performance UniBloc Balances

Provides High-speed Response and High Stability  
A New Stage in Analytical Balance Performance

## High Speed

The response time for trace measurements (from 1 mg) is reduced to about 2 seconds.  
This significantly improves weighing efficiency.

## Stress Free

The STABLO-AP ionizer can be mounted.  
This eliminates the influence of static electricity, achieving reliable measurements in a simpler procedure.

## For Regulation

Interlocking with LabSolutions Balance enables compliance with a variety of regulations for measurement data integrity, including ISO 17025 for testing laboratories, ISO 9001 and ISO 14001 for the manufacturing industry, and GLP/GMP and the United States Pharmacopeia (USP) for the pharmaceutical industry.

## For HPLC

Functions are included for the preparation of buffer solutions used in HPLC.  
As a result, the operation can be performed accurately and easily, even by non-specialists.

## Save Your Operation

Equipped with USB as standard\*1. Includes many diverse functions to support users.

\*1 All models: USB-B type connector as standard AP-W Series: USB-A type and B type as standard



\* AP324W with optional ionizer



Watch the AP overview video on our website.  
<http://www.shimadzu.com/an/balance/analytical/ap.html>

# High Speed

Fast measurement significantly improves operational efficiency.

## Fast Response with UniBloc AP Technology

Shimadzu analytical balances boast a one-piece UniBloc weighing sensor, which is now even more advanced.

The response time is reduced to about 1/5 the time of previous models.

The improved UniBloc sensor offers a response time of just 2 seconds, an improvement from 10 seconds with the previous model.

Response During Trace Measurements with the 0.01 mg Model  
(Equivalent to 1 mg / With Conditions Set by Shimadzu)

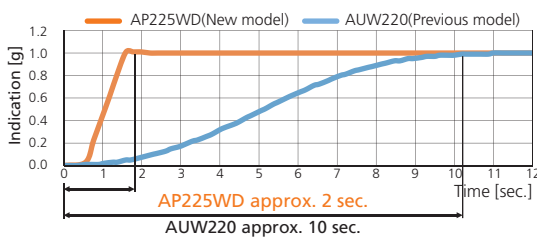

Response During Trace Measurements with the 0.1 mg Model  
(Equivalent to 1 mg / With Conditions Set by Shimadzu)

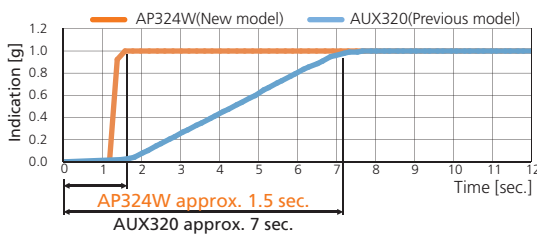

Model	Previous Model	AP Series
0.01 mg	10 sec.	2 sec.
0.1 mg	7 sec.	1.5 sec.



\* AP135W

## Advanced Digital Control for Fast, Reliable Weighing

The improved measuring feel provides more comfortable use.

AP-i System (intelligent - Advanced Processing System)

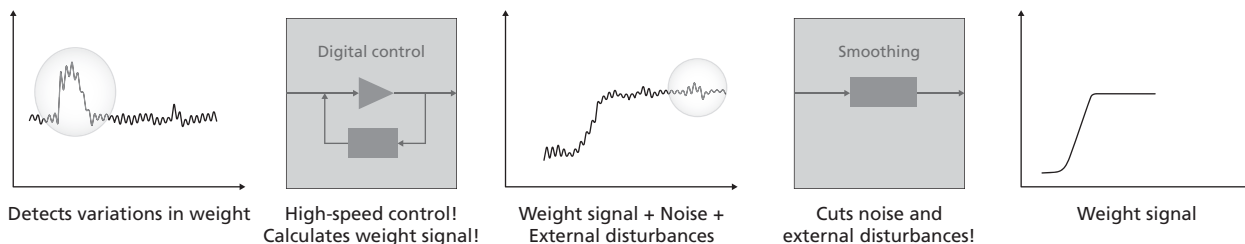

Measuring feel has been significantly improved by using the advanced digital control technology and smoothing technology.

AP-i system provides reliable weighing even in an environment with significant external disturbances. This promises to increase the efficiency of your measurement operations.



# Stress Free

A variety of accessories and options suitable for semi-micro measurements

## The multi stand can be used freely and easily.

(0.01 mg model only, equipped as standard)



With weighing paper, for example, if the tare is larger than the pan diameter, measurements can be simplified by attaching the special multi stand.



Measuring weights with a pipette can be simplified by placing a micro tube upright in the sample holder in the special multi stand.



Long rod-shaped samples can be measured in a stable state by placing them in the slot in the special multi stand.



The internal windbreak plate suppresses the influence of convection and airflow within the weighing chamber, improving the stability and response of measurement values.

## Built-in High-Performance Ionizer (Optional)

The ionizer eliminates influence of static electricity in 1/10 the time of previous models.

Note: Example of typical static electricity removal time ( $\pm 1000\text{ V} \rightarrow \pm 100\text{ V}$ )  
1 sec. for STABLO-AP and 10 sec. for STABLO-EX



## AC Method with Excellent Ion Polarity Balance

Mount the STABLO-AP in the balance and use it as a built-in model

Comparison of Neutralization Speed (Representative Values)

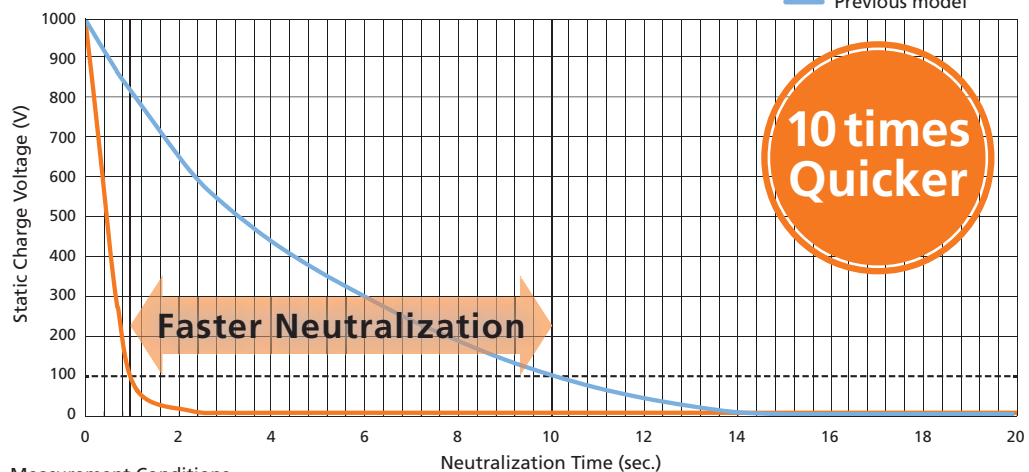

Measurement Conditions

- Time from  $\pm 1000\text{ V}$  to  $\pm 100\text{ V}$
- Distance between CPM and ionizer: 100 mm
- For this evaluation, a 150 x 150 mm charged plate monitor (CPM, 20pF) was used.

# For Regulation for the Pharmaceutical Industry

## High-Security User Management **NEW**

(All models)

Operations can be kept secure with user ID and password protection. Access rights can be specified separately for each user to prohibit unauthorized actions such as performing calibration or changing the settings. User IDs can also be used for barcode management.



User Selection Screen

## Printing Data in Accordance with Various Regulations **NEW**

(All models)

Printing can be customized to indicate when the measurements were taken and by whom. Users are free to set which items are to output, and in what order. The date, time, calibration log, and other information can be printed depending on the purpose of printing, which supports compliance with ISO, GLP, and GMP.

<Printed content>

- Date
- Time
- User name
- Balance manufacturer name
- User ID
- Serial number
- Balance ID
- Software version
- Minimum sample quantity
- Blank line
- Ruled line (-----)

An example of printing

Title of result	-----CAL-INTERNAL
Manufacturer name	SHIMADZU CORP.
Model name	TYPE AP324W
Serial number	SN 000000001
Date	DATE 2014 Dec.17
Time	TIME 15.51.55
User name	YAMADA TARO
Standard weight value	REF= 300.0000g
Weighing value before calibration	BFR= 299.9888g
Weighing value after calibration	AFT= 300.0000g
	-COMPLETE
Signature	-SIGNATURE-

## Minimum Measurement Value (Warning Function) **NEW**

(All models)

Reproducibility can be confirmed by repeatedly measuring weights as instructed by AP series. The minimum sample quantity is automatically determined from the standard deviation and recorded in AP series.

If the minimum sample quantity requirement is not satisfied during measurement, an indicator flashes to warn the user.



Minimum sample quantity

## Recipe Function **NEW** (Achieve Your Preferred Compounding Process) (AP-W Series only)

Sample recipes can be registered, allowing users to simply follow displayed instructions. This is convenient when compounding medicines.

# Solutions to Improve Operational Efficiency and Ensure Data Reliability

## LabSolutions Balance Analytical Network Data System Compliant with ER/ES Regulations

- Eliminate manual entry, and all the weighing data are saved automatically in a safe database without transcription mistakes.
- Reports appropriate for weighing methods, such as the mass variation test, drying weight loss test and particle size test, can be created automatically after the measurement. In addition, customized reports featuring such information as system conformance, content uniformity and elution tests together with the analysis results obtained by HPLC, etc. can be created.

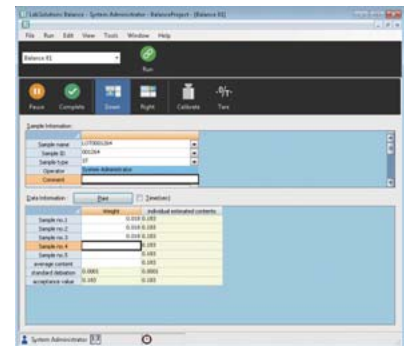

Main Window of LabSolutions Balance

### Integrated Management of Analytical Data on Network System Using LabSolutions

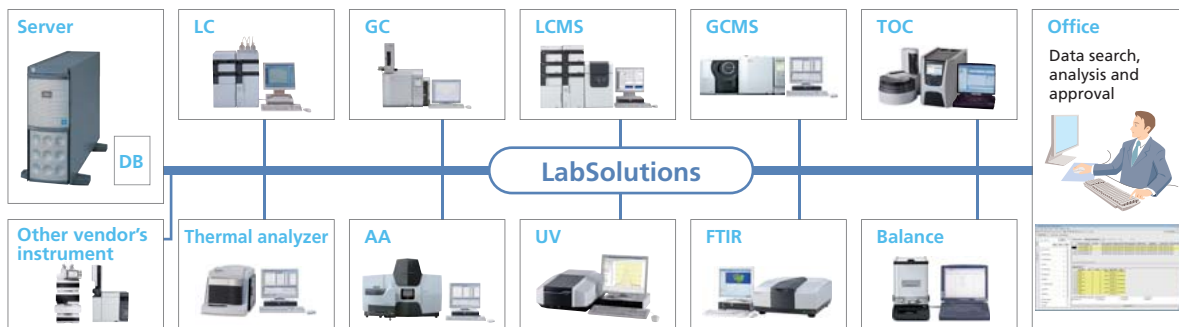

### Compliant with the Latest Data Integrity Guidance (U.S. FDA 21 CFR Part 11)

- Weighing results can be automatically saved in the database together with other information, including sample ID, operator name, operation date and series number of instrument used. This enables quick data searching based on sample information.
- It allows setting up user authority to ensure only the authorized user can create a template for weighing.
- It prevents improper manipulation, unintended overwriting and deletion of data. In addition, measurement results, all the operation histories and reasons will be saved in the database as log files.

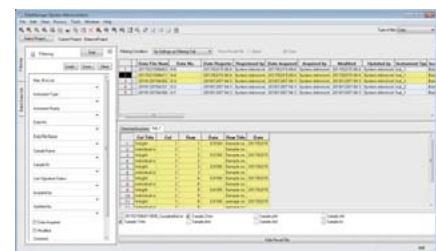

LabSolutions Data Manager

### Integrated Report Creation Function Combines Analysis Results from HPLC and Weighing Results from Balance

#### Creation of Report Template

It enables creating the report by reading sample data and confirming the sample report at the same time.

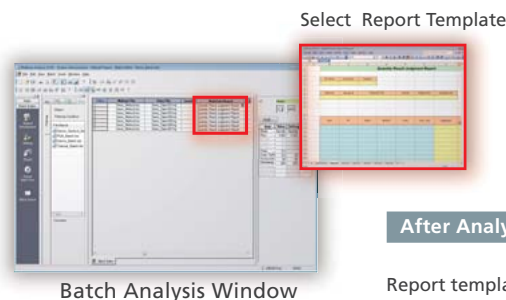

After Analysis

Report template formats can be freely customized. Automatically print reports and create PDF files.

Note: Multi-data report creation (optional) is necessary to use this function.



## Buffer Solution Preparation Mode **NEW**

(AP-W Series only)

- **Recipes for 13 commonly used buffer solutions are included as standard**

Preparation recipes for commonly used buffer solutions are provided as standard.

e.g. disodium phosphate, sodium acid citrate

- **New buffer solution recipes can be registered**

If a buffer solution is not registered by default, it can be newly registered.

- **Instructions are shown on the display**

The target weighing value is shown on the display and analog bar in order to compare the target with the current weight. Manual calculation is not needed.

- **Record function**

Record output with date, time and operator name.

The pH level of mobile phase (eluent) solutions used in liquid chromatographs is adjusted to improve separation of components and extend the life of columns. This pH adjustment process is performed using a buffer solution. Currently, the most common method is using a pH meter to measure the pH as the solution is prepared; however, this process requires considerable time and effort, which can cause operational bottlenecks. An alternative method does not require a pH meter. It involves preparing solutions by weighing fixed theoretically calculated quantities of an acid and base.

AP series supports weighing these acids and bases. If the type and quantity of the buffer solution are specified, the balance displays the type and quantity of sample that should be weighed. Then the buffer solution can be prepared easily by adding water to the specified quantity of sample weighed accordingly.

Preparation example: When weighing and preparing 50 mM of di-sodium hydrogen phosphate, 2-hydrate and 50 mM of sodium dihydrogenphosphate, 2-hydrate in order to prepare 3 L of 100 mM phosphoric acid (sodium) buffer solution at pH=2.1:

Example of preparation by AP series

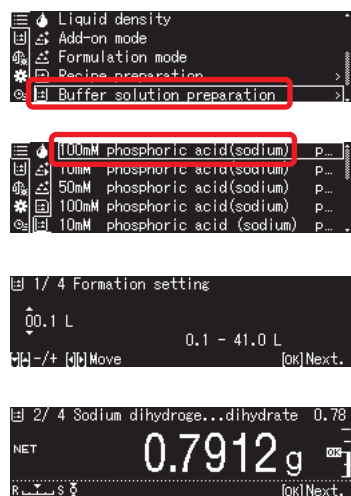

- Select the buffer solution mode.
- Specify the type and quantity.
- Displays the name and quantity of sample.
- Prepare as instructed on screen.

Complete buffer solution



Number	Concentration	Buffer solution preparation list	pH
1	100mM	phosphoric acid (sodium)	pH = 2.1
2	10mM	phosphoric acid (sodium)	pH = 2.6
3	50mM	phosphoric acid (sodium)	pH = 2.8
4	100mM	phosphoric acid (sodium)	pH = 6.8
5	10mM	phosphoric acid (sodium)	pH = 6.9
6	20mM	citric acid (sodium)	pH = 3.1
7	20mM	citric acid (sodium)	pH = 4.6
8	10mM	tartaric acid (sodium)	pH = 2.9
9	10mM	tartaric acid (sodium)	pH = 4.2
10	20mM	acetic acid (ethanolamine)	pH = 9.6
11	100mM	acetic acid (sodium)	pH = 4.7
12	100mM	boric acid (potassium)	pH = 9.1
13	100mM	boric acid (sodium)	pH = 9.1

\* Results can be printed with date/time and user ID.

## Sample Preparation **NEW**

(AP-W Series only)

When preparing a standard solution from a particular component, the standard powder for this component will be a hydrochloride or a hydrate. Preparing a standard solution of the target component at a desired requires difficult calculations prior to weighing it. With the AP series, however, the required weight value is automatically calculated, so it can be weighed without performing manual calculations.

Example of preparation by AP series

Weigh 25 mg Amitriptyline to make a standard solution

Standard sample of Amitriptyline is Amitriptyline Hydrochloride.

Calculation is essential to determine part of Acidum hydrochloricum by molecular weight in order to make a 100 mg/mL Amitriptyline solution.

Molecular weight of Amitriptyline: 277.4

Molecular weight of Acidum hydrochloricum: 36.5

Molecular weight of Amitriptyline Hydrochloride:  $277.4 + 36.5 = 313.9$

To compare the molecular weight of Amitriptyline Hydrochloride with Amitriptyline, the following calculation is necessary.

$313.9/277.4 = 1.132$

The molecular weight of Amitriptyline Hydrochloride is 1.132 times of Amitriptyline.

So, if 25mg of Amitriptyline is used, it follows that the weight of Amitriptyline Hydrochloride should be:

$25 \text{ mg} \times 1.132 = 28.3 \text{ mg}$ .

Hence, 28.3 mg of Amitriptyline Hydrochloride is needed to make the correct standard solution.

Standard solution of Amitriptyline

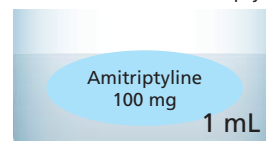

Amitriptyline Hydrochloride

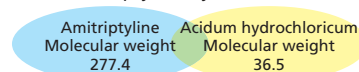

No need for manual calculation

AP series can automatically calculate the sampling weight using the molecular amount of the standard sample, molecular weight of unnecessary sample, and the target value in order to reach the correct concentration solution.

Just weigh the target weight value on display and the target weight of the standard sample can be obtained.

Target weighing value	→	Target	0.0283 g		"OK" mark shown when target weight is reached.
Current sample value	→	Gross	0.0283 g		
Standard sample value	→	Picking	0.0250 g		

Sample preparation AMITRIPTYLINE

Checking weighing conditions on the same display

# Save Your Operation

Equipped with USB as standard.\*1 Includes many diverse functions to support users.

\*1 AP-W Series only

## USB Offers Greater Expandability **NEW**

(USB host: AP-W Series only)

Equipped with an RS-232C connector, a USB device and a USB host as standard. You can now simultaneously send output to both a computer and printer or connect a USB flash drive, a barcode reader, or an external numeric keypad.

Transcription errors can be avoided and data can be recorded without a computer.



USB and RS-232C are standard

USB host is available for AP-W Series

### USB flash drive

Connecting a USB memory device allows you to record large amounts of weighing data in CSV format. Used in combination with the interval output function, it also enables recording of long-term changes over time.



Example of a record:

File name  
Date and time  
Weighing value

\*The information saved will differ depending on the function used.

### Display capture function

Weighing display can be recorded into USB memory in BMP format. User name, date/time, and setting can be shown with display information.

The user name, time, measurement conditions, pass/fail judgments, and other information displayed on screen can be saved as is, enabling the recording of measurements, and checks after measurements.



### Numeric keypad

Connecting a common external numeric keypad makes it easier to enter numeric values. This is especially useful for entering the mass value of weights, setting upper/lower limit values for the comparator function, or entering the sample count during piece counting mode.



### Barcode reader

A barcode reader can be connected. Simply reading a barcode makes it possible to input user ID/Password. It is possible to manage sample IDs using barcodes.



An example of login by barcode

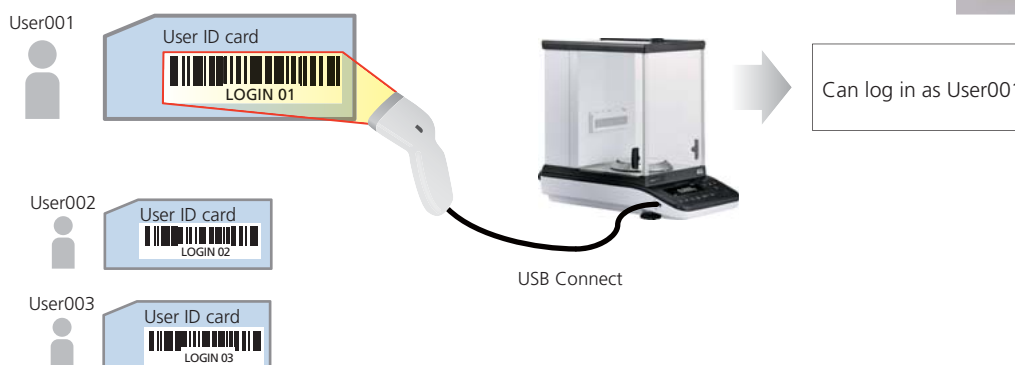

An ID and password are needed to log in to the AP series if protected access is activated. With the barcode, an operator can log in by scanning the barcode instead of inputting an ID and password.

\* The latest information can be seen from the Shimadzu website (<http://www.shimadzu.com/an/balance/>)

## Easy-to-Read Organic EL Display

(All models)

Because the pixel elements in the organic electroluminescence display emit light, the screen can be seen clearly even in dark locations. Multi-language display capability\*2 provides a more intuitive operating interface. A wider viewing angle has also improved the visibility of measurement values, which helps increase the efficiency of measuring operations.

\*2 Japanese, English and Chinese



Clearly visible from the side

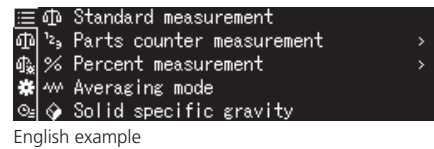

### Exceptional Visibility

The visibility remains the same even when viewed from different angles. The viewing angle is a wide expanse of  $\pm 85$  degrees, both vertically and horizontally. That means the display is clearly visible even when working beside the balance. A high-resolution dot-matrix display makes it easy to read detailed text.

## Periodic Inspection Support Function **NEW**

(AP-W/AP-X Series only)

AP series supports periodic inspections. The function allows inspection of repeatability, corner load error, and linearity by simply following instructions displayed on the screen.

### Example of printing

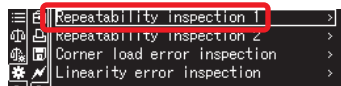

Select the inspection mode.

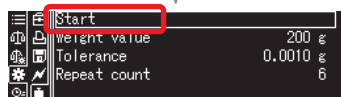

In this case, repeatability inspection is selected.



Place standard weights as instructed.

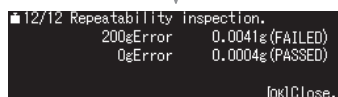

Results are displayed.

### Printing sample

REPEATABILITY	
LOAD	= 150 g
MPE	= 0.0010 g
-----	
N001	IL = 150.0000 g
I0	= 0.0000 g
N002	IL = 149.9999 g
I0	= -0.0001 g
N003	IL = 149.9999 g
I0	= -0.0001 g
N004	IL = 149.9999 g
I0	= 0.0000 g
N005	IL = 149.9999 g
I0	= 0.0000 g
N006	IL = 149.9999 g
I0	= 0.0000 g
TEST RESULTS	
LOAD	= 0.0001 g (PASSED)
ZERO	= 0.0001 g (PASSED)

IL: Loaded weight  
I0: Zero value

# Wide Variety of Functions to Support Users

## Smart Settings

(All models)

Response and stability settings can be changed during measurements with a single touch. Changing the settings for different applications can make it even easier to use.



User-friendly arrow keys

The indicator is operated using the left and right arrow keys. Moving the setting toward [R] prioritizes response, which makes it easier to operate the balance. Conversely, moving it toward [S] makes it easier to stabilize weight values, which can improve readability in environments with vibration.



Moving it left prioritizes response and moving it right prioritizes stability. Five setting levels are available.

## Specific Gravity Measurement

(All models)

In combination with an optional specific gravity measurement kit, the balance can be used to measure specific gravity. Operations are simplified by a text-based navigation function. By using sinkers, the specific gravity of liquid can be measured as well. This allows measuring the specific gravity of metals, rubbers, plastics, and other materials easily.



First measure the empty weight.



Then place it in the container filled with water, as instructed on the screen.



The specific gravity value is displayed using simple steps.



## PSC and Clock-CAL

(AP-W/AP-X Series only)

A Perfect Self Calibration (PSC) function is included. The analytical balance automatically detects any temperature changes that could affect sensitivity and automatically starts calibration.

The Clock-CAL function enables automatic calibration at a pre-specified time (for example, before starting work, during lunch, or after work hours).

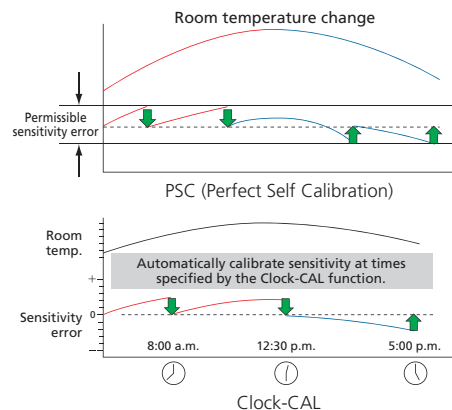



# Recommended Functions of AP Series for Each Industry

Various user support functions are available in AP series.

AP series provides solutions for each industry as follows.

## Chemical



The aluminum die-cast body adopted for the AP series is highly chemical resistant, and is optimal for the measurement of liquid samples. In addition, functions are provided to support the preparation of various samples, and the preparation of buffer solutions for liquid chromatographs, which makes this series an excellent match to a variety of Shimadzu analytical instruments.

Improved response allows weighing liquid and powder samples in a stress-free manner.

- Built-in ionizer
- Printing format customize
- USB accessories
- Periodic inspection support
- Buffer solution preparation
- Sample preparation
- Barcode reader function

## Pharmaceutical



In the pharmaceutical industry, high-level measurement accuracy is required. A mass sensor, the UniBloc AP, has been adopted for the AP series, to provide both reliable accuracy and excellent durability. The series is equipped with a printing function to comply with ISO, GLP, and GMP; a function to support inspections to maintain accuracy; and a function to warn when a sample that weighs less than the minimum measurement value is weighed, all of which support your activities.

Even if multiple samples are measured, data can be recorded on a USB flash drive, which makes it easy to utilize the data.

- Built-in ionizer
- Printing format customize
- USB accessories
- Periodic inspection support
- Minimum sample quantity
- Buffer solution preparation
- Sample preparation
- Barcode reader function

## Food



With the importance of food safety and traceability, accuracy is needed for weight measurements, which are the basis of analysis. With the AP series, calibration can be performed via built-in weights, and functions such as PSC, which detects changes in room temperature and automatically adjusts the sensitivity, and Clock-CAL, which is used at the specified time, are included. As a result, users can use the AP series more confidently. In addition, combining the AP series with the STABLO-AP ionizer, which eliminates the influence of static electricity, ensures good measurements with more stable repeatability.

- Built-in ionizer
- Printing format customize
- USB accessories
- Periodic inspection support
- Buffer solution preparation
- Sample preparation
- Barcode reader function

## Automobile and Metal Industry



In the automobile industry the demand for accuracy controls is heightened each year. Utilizing the inspection support function, which supports routine and periodic inspections, makes it easy to accommodate this demand.

In addition, measuring the specific gravity of metals is a strength of the AP series. Using the AP series in combination with the optional specific gravity measurement kit makes it easy to find specific gravity values at a low cost. This is recommended for the quality control of parts.

- Printing format customize
- USB memory
- Periodic inspection support
- Barcode reader function

## Academia



The AP series is also useful in government agencies and universities. Many students will come in contact with the balance during hands-on training at university, so durability is of importance. The AP series is equipped with the UniBloc AP mass sensor, which is very shock resistant, so the AP series can be used with confidence. A number of chemicals are stored at government agencies and universities. By connecting the balance with the CRIS chemicals management system, the amount of deleterious substances used can easily be managed.

- Built-in ionizer
- Printing format customize
- USB memory
- Buffer solution preparation
- Sample preparation

\* Ionizer, printer and specific gravity kit are optional items.

# AP Series Specifications

## W Series Analytical Balances

Series	W Series					
Model	AP135W	AP125WD	AP225WD	AP124W	AP224W	AP324W
Capacity	135 g	120 g / 52 g	220 g / 102 g	120 g	220 g	320 g
Minimum Display	0.01mg	0.01 mg / 0.1 mg		0.1 mg		
Calibration Weight	Built-in					
External Calibration Weight Range for Span Calibration	45 to 135.0009 g (100 g)	45 to 120.0090 g (100 g)	95 to 220.0090 g (200 g)	45 to 120.009 g (100 g)	95 to 220.009 g (200 g)	95 to 320.009 g (300 g)
Repeatability (Standard deviation)	0.05mg	0.1 mg / 0.02 mg	0.1 mg / 0.05 mg	0.1 mg		0.15 mg
Repeatability (for Low Loads)	0.015 mg (5 g low loads)			0.1 mg (5 g low loads)	0.1 mg (10 g low loads)	0.1 mg (20 g low loads)
Minimum Weight *1	30 mg			200 mg		
Linearity	±0.1 mg	±0.2 mg / ±0.05 mg	±0.2 mg / ±0.1 mg	±0.2 mg		±0.3 mg
Response Time for Trace Measurements *2	2 sec.					
Response Time *3	8 sec.	2 sec. / 8 sec.		2 sec.		
USB Host (Type A)	Included					
USB Device (Type B)	Included					
Recipe Compounding	Included					
HPLC Buffer Solution Preparation	Included					
mol Conversion Function	Included					
Sample (Concentration) Preparation	Included					
Inspection Support Function	Included					
Clock-CAL	Included					
Ionizer	Optional					
Operating Temperature/Humidity Range	5 to 40°C 20 to 85% *4					
Sensitivity Stability Against Temperature Range	±2 ppm/°C (10 to 30°C)					
Pan Size	ø91 mm					
Body Dimensions	Approx. 212 (W) × 411 (D) × 345 (H) mm (power supply unit included)			Approx. 212 (W) × 367 (D) × 345 (H) mm		
Weight	Approx. 7.9kg			Approx. 7.0 kg		
Display	OEL display (dot matrix)					
Input/Output Terminal	RS-232C (D-sub9P plug) USB host (Type A) USB device (Type B) Ionizer					

## X Series / Y Series Analytical Balances

Series	X Series			Y Series		
Model	AP124X	AP224X	AP324X	AP124Y	AP224Y	AP324Y
Capacity	120 g	220 g	320 g	120 g	220 g	320 g
Minimum Display	0.1 mg					
Calibration Weight	Built-in			No		
External Calibration Weight Range for Span Calibration	45 to 120.009 g (100 g)	95 to 220.009 g (200 g)	95 to 320.009 g (300 g)	45 to 120.009 g (100 g)	95 to 220.009 g (200 g)	95 to 320.009 g (300 g)
Repeatability (Standard deviation)	0.1 mg		0.15 mg	0.1 mg		0.15 mg
Repeatability (for Low Loads)	0.1 mg (5 g low loads)	0.1 mg (10 g low loads)	0.1 mg (20 g low loads)	0.1 mg (5 g low loads)	0.1 mg (10 g low loads)	0.1 mg (20 g low loads)
Minimum Weight *1	200 mg					
Linearity	±0.2 mg		±0.3 mg	±0.2 mg		±0.3 mg
Response Time for Trace Measurements *2	2 sec.					
Response Time *3	2 sec.					
USB Host (Type A)	Not Included					
USB Device (Type B)	Included					
Recipe Compounding	Not Included					
HPLC Buffer Solution Preparation	Not Included					
mol Conversion Function	Included			Not Included		
Sample (Concentration) Preparation	Not Included					
Inspection Support Function	Included			Not Included		
Clock-CAL	Included			Not Included		
Ionizer	Optional			Not Included		
Operating Temperature/Humidity Range	5 to 40°C 20 to 85% *4					
Sensitivity Stability Against Temperature Range	±2 ppm/°C (10 to 30°C)					
Pan Size	ø91 mm					
Body Dimensions	Approx. 212 (W) × 367 (D) × 345 (H) mm					
Weight	Approx. 7.0 kg			Approx. 6.5 kg		
Display	OEL display (dot matrix)					
Input/Output Terminal	RS-232C (D-sub9P plug)	USB device (Type B)	Ionizer	RS-232C (D-sub9P plug)	USB device (Type B)	

\*1 According to USP Chapter 41. This is the tested value by the weight of the balance's capacity of 5%.

\*2 The response time for displaying 90% of added sample amount value in trace measurements (from 1mg)

\*3 The response time value is typical.

\*4 Non-condensing.

# AP Series

0.01 mg / 0.1 mg model

- AP135W (0.01 mg)
- AP125WD(0.01 mg / 0.1 mg)
- AP225WD(0.01 mg / 0.1 mg)



\* Power supply unit included.

0.1 mg model

- AP124W AP124X AP124Y
- AP224W AP224X AP224Y
- AP324W AP324X AP324Y



## Options



STABLO-AP Ionizer



EP-100 Electronic Printer



EP-110 Electronic Printer  
(multifunction printer with liquid crystal display)



SMK-601

Specific Gravity Measurement Kit



Internal Windbreak Plate

## Options

- 
- Static Electricity Remover STABLO-AP Ionizer

---

  - Electronic Printer EP-100

---

  - Electronic Printer EP-110 (Multifunction Printer with Liquid Crystal Display)

---

  - Label Roll Paper for EP-100/110 (10 Rolls)

---

  - Specific Measurement Kit SMK-601

---

  - Display Protective Cover (Set of 5)

---

  - USB Cable

---

  - AC Adapter (Standard Accessory)

---

  - Internal Windbreak Plate

---

  - RSIO Interface Cable

---

## External Dimensions of AP Series

(AP135W, AP125WD, AP225WD) Weight: Approx. 7.9 kg

(AP124W, AP224W, AP324W, AP124X, AP224X, AP324X) Weight: Approx. 7.0 kg

(AP124Y, AP224Y, AP324Y) Weight: Approx. 6.5 kg

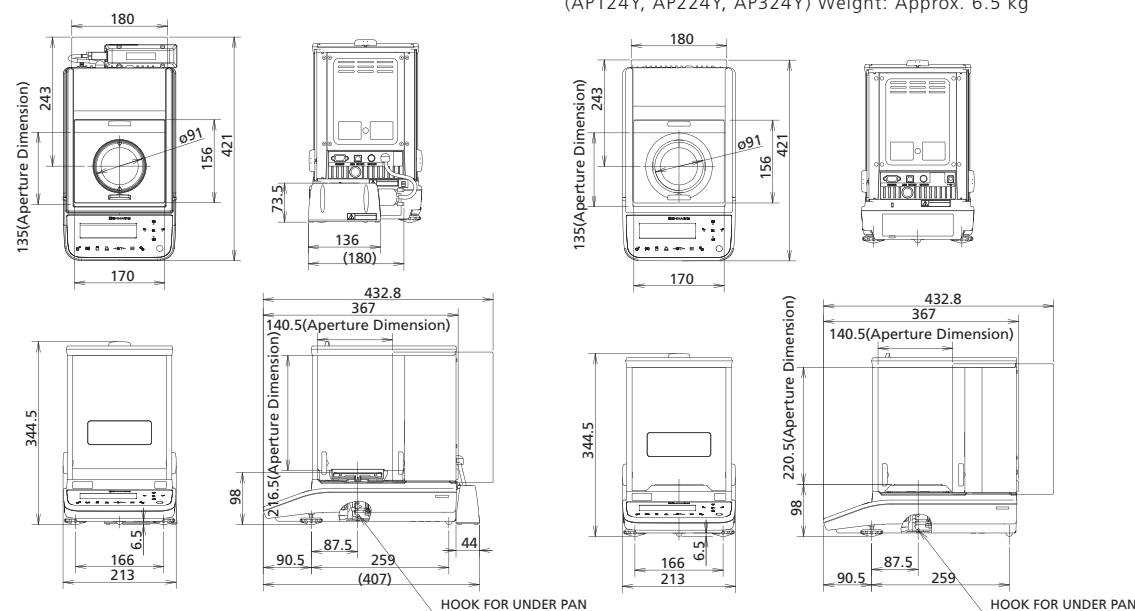

## External Dimensions of STABLO-AP

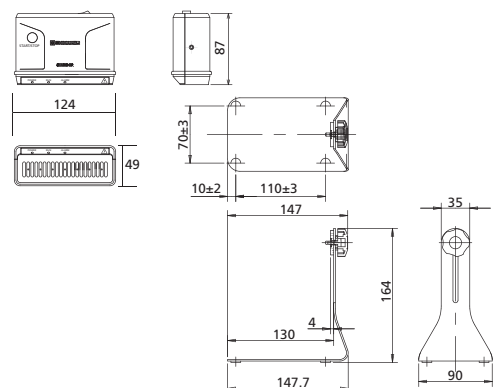

### Static Electricity Remover STABLO-AP

2-Way Ionizer Designed Specifically for Electronic Balances

Ion Generation Method	AC corona discharge method
Ion Balance	±10 V
Effective Static Removal Range	Approx. 50 mm to 400 mm from the outlet
Static Elimination Time (approx.)	1 second (Typical value) (from ±1000 V to ±100 V)
Ozone Concentration	Max. 0.06 ppm (at 150 mm from the center of the nozzle)
Electrode Probes	Tungsten (durability: 30,000 hours)
Weight	Approx. 710 g (Main unit: 395 g, Stand: 315 g)
Operating Temperature and Humidity	0 °C to +40 °C, 25 % RH to 85 % RH (non-condensing)
Rated Electric Power Supply	DC 24 V, 1.0 A
Dimensions	Approx. 124 × 87 × 49 mm

\*1: Typical values when measured with a 20 pF 150 mm x 150 mm charged plate monitor (CPM), at 100 mm from the center of the nozzle (at the time of shipment)

\*2: Elimination time from a static charge of ±1000 V down to ±100 V, at 100 mm from the center of the nozzle (at the time of shipment)



**For Research Use Only. Not for use in diagnostic procedures.**

This publication may contain references to products that are not available in your country. Please contact us to check the availability of these products in your country.

Company names, products/service names and logos used in this publication are trademarks and trade names of Shimadzu Corporation, its subsidiaries or its affiliates, whether or not they are used with trademark symbol "TM" or "®".

Third-party trademarks and trade names may be used in this publication to refer to either the entities or their products/services, whether or not they are used with trademark symbol "TM" or "®".

Shimadzu disclaims any proprietary interest in trademarks and trade names other than its own.

The contents of this publication are provided to you "as is" without warranty of any kind, and are subject to change without notice. Shimadzu does not assume any responsibility or liability for any damage, whether direct or indirect, relating to the use of this publication.

Shimadzu Corporation

[www.shimadzu.com/an/](http://www.shimadzu.com/an/)